



**RICAMBI  
CUSTODIA FISSA 3 POLI + TERRA**

**CENTRALINE DI TERMOREGOLAZIONE**

CUSTODIA FISSA 3 POLI + TERRA



CUSTODIA FISSA 3 POLI + TERRA,  
con 1 leva, grandezza "21.21"

DISEGNI A CATALOGO

CKA I

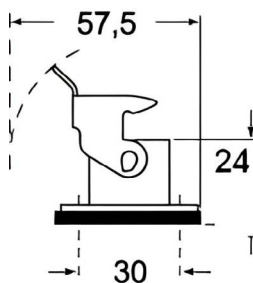

CKAX I

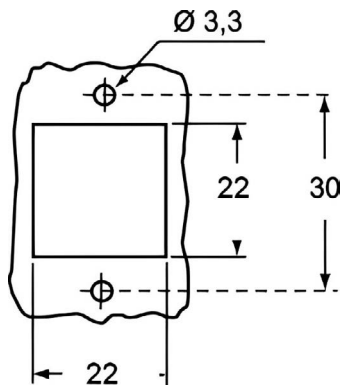
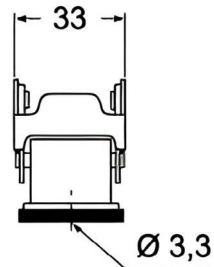
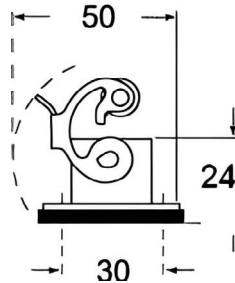
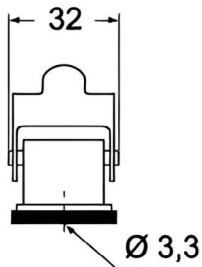



**RICAMBI  
CUSTODIA FISSA AD ANGOLO  
3 POLI + TERRA**

CENTRALINE DI TERMOREGOLAZIONE

CUSTODIA FISSA AD ANGOLO 3 POLI + TERRA



CUSTODIA FISSA AD ANGOLO 3 POLI + TERRA, con 1 leva, senza ingresso cavo, grandezza "21.21"

DISEGNI A CATALOGO

CKA IA

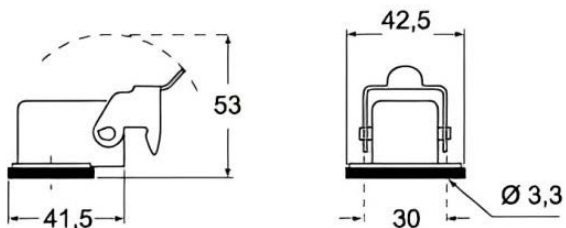

CKAX IA

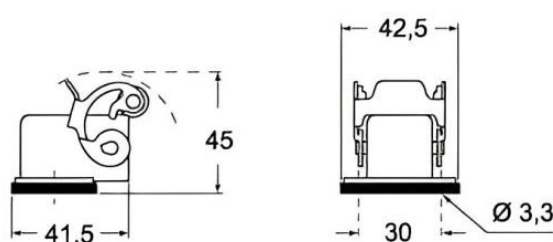

CKA IAPS (CKA APS) MKA - IAP (MKA AP)

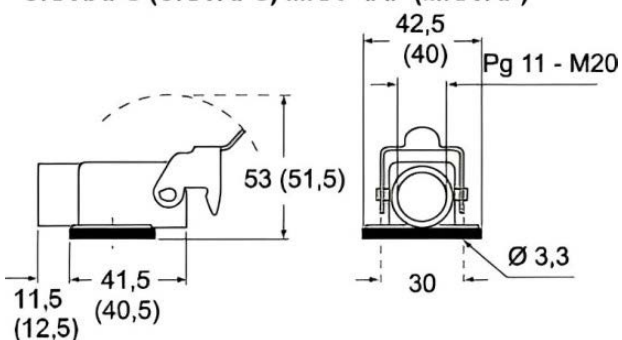

CKAX IAPS (CKAX APS) - MKAX IAP (MKAX AP)

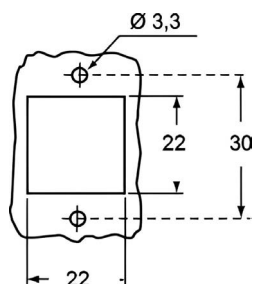
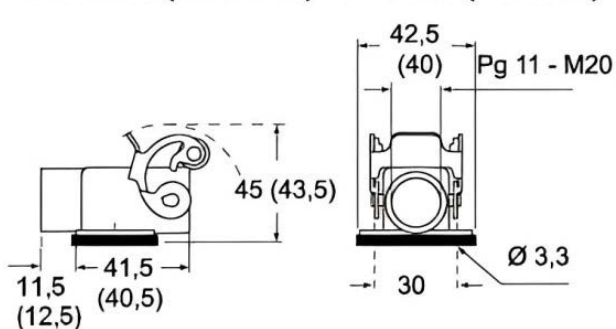



[www.eleNorm.com](http://www.eleNorm.com)



**RICAMBI  
CUSTODIA BASSA FISSA 6 POLI**

**CENTRALINE DI TERMOREGOLAZIONE**

CUSTODIA BASSA FISSA 6 POLI



CUSTODIA BASSA FISSA 6 POLI,  
con 1 leva, grandezza "44.27"

DISEGNI A CATALOGO

CHI L

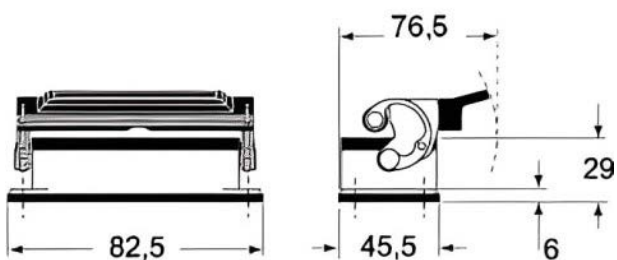

CHI LS

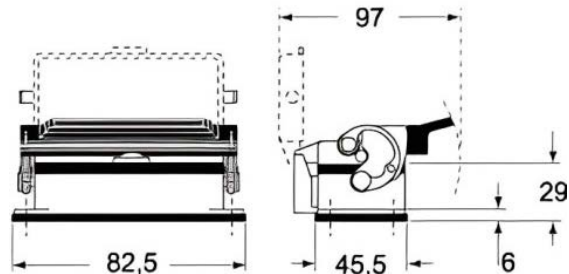

CHI LC

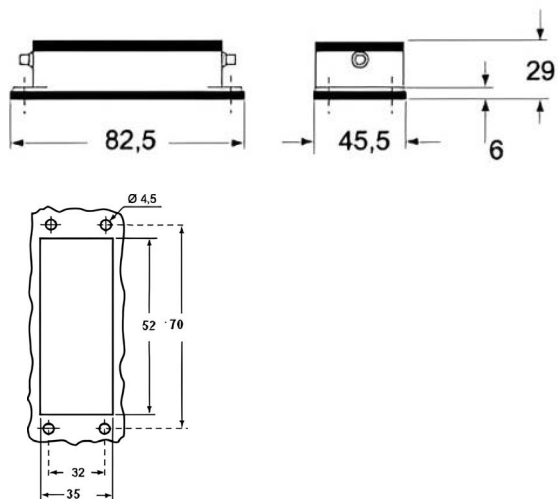

CHI LGS/LCP

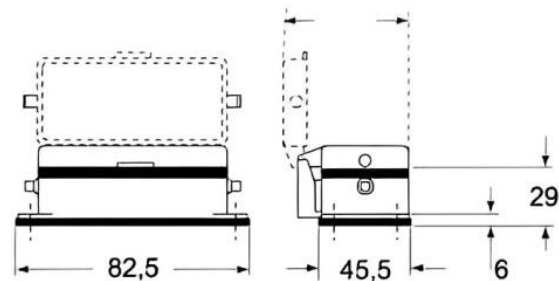



**RICAMBI  
CUSTODIA BASSA FISSA 10 POLI**

**CENTRALINE DI TERMOREGOLAZIONE**



CUSTODIA BASSA FISSA 10 POLI

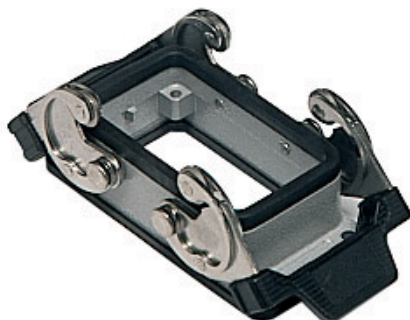

CUSTODIA BASSA FISSA 10 POLI,  
con 2 leve, grandezza "57.27"

DISEGNI A CATALOGO

**CHI**

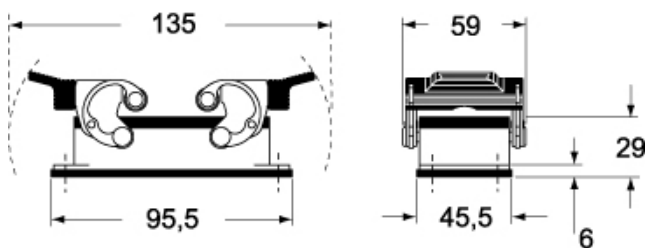

**CHI C**

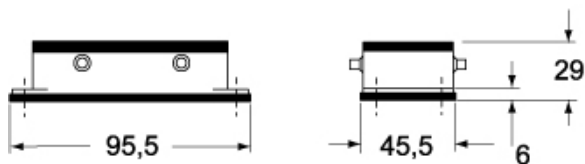

**CHI CS/CP**

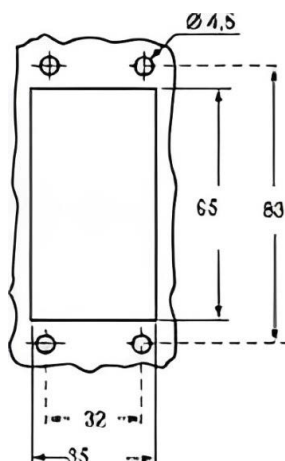
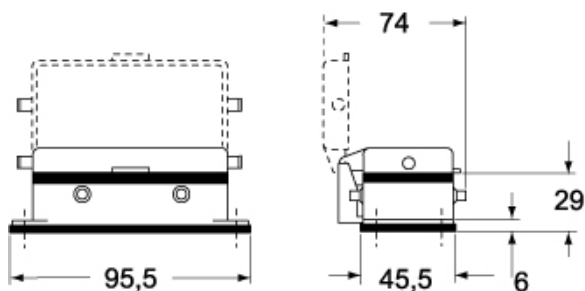



**RICAMBI  
CUSTODIA BASSA FISSA 16 POLI**

**CENTRALINE DI TERMOREGOLAZIONE**

CUSTODIA BASSA FISSA 16 POLI



CUSTODIA BASSA FISSA 16 POLI,  
con 2 leve, grandezza "77.27"

DISEGNI A CATALOGO

CHI

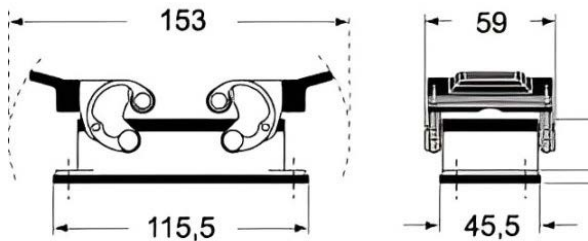

CHI C

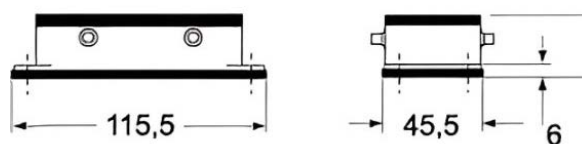

CHI CS/CP

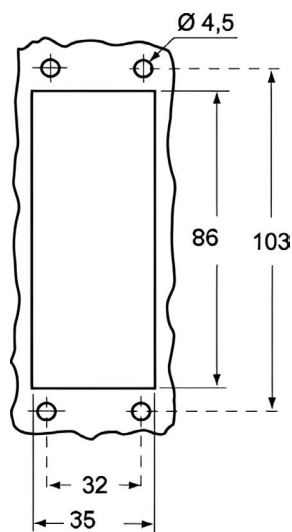
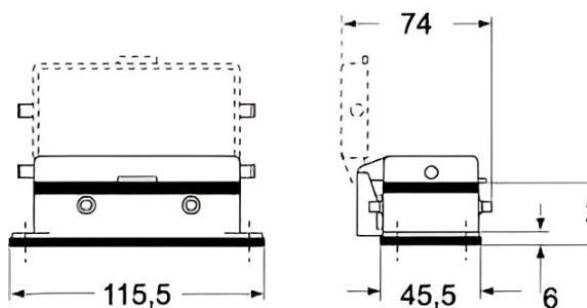



**RICAMBI  
CUSTODIA BASSA FISSA 24 POLI**

**CENTRALINE DI TERMOREGOLAZIONE**

CUSTODIA BASSA FISSA 24 POLI



CUSTODIA BASSA FISSA 24 POLI,  
con 2 leve, grandezza "104.27"

DISEGNI A CATALOGO

CHI

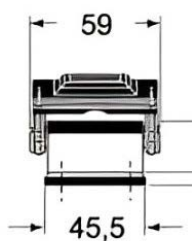
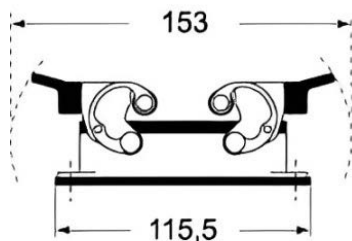

CHI C

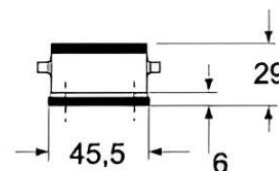
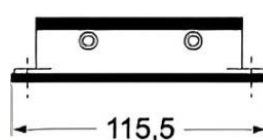

CHI CS/CP

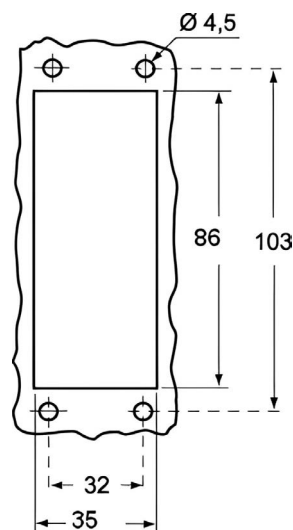
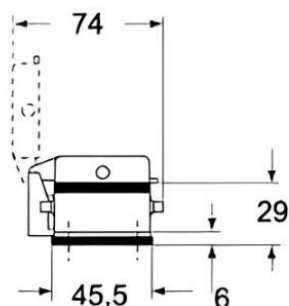
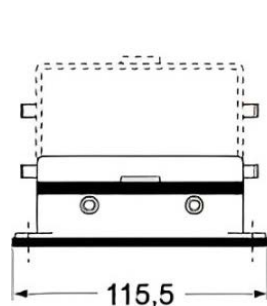



[www.eleNorm.com](http://www.eleNorm.com)